

Service manual

Version: 2.00

Ident: B1-EBO 128

Series: EBO

Part-Number: 500170

This part can be ordered.



Chapter

- 500173 - Baking Chamber EBO128 400V 50Hz - V:2.00
- 500174 - Control EBO - V:2.00
- 500172 - Door EBO 124/128 - V:2.00
- 500183 - Electric-Installation digital/MAN - V:2.00
- 500184 - Electric-Installation IS 500/600 - V:2.00
- 500176 - Frame EBO - V:2.00
- 500175 - Installationroom EBO128 400V 50Hz - V:2.00

Service manual

Baking Chamber EBO128 400V 50Hz

Version: 2.00

Ident: B1-EBO 128

Series: EBO

Part-Number: 500173

This part can be ordered.

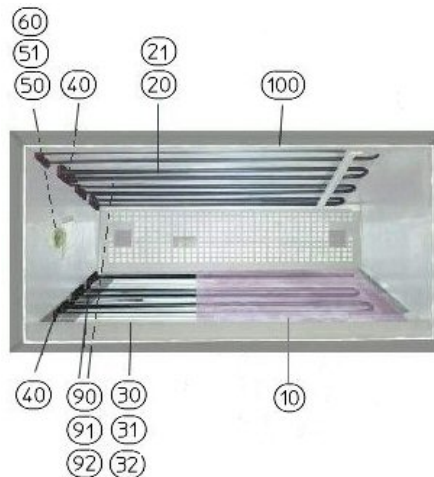

Chapter

- 70508 - EBO Frame for lamps-lower part
- 70509 - EBO protective glass f. lamps-lower part
- [010] - 105690 - Stone plates EBO 128
- [030] - 105683 - Seal for tube heater
- [030] - 403112 - Tube Heater 500W / 230V
- [031] - 403113 - Tube Heater 700W /230V
- [040] - 70179 - Halogen Lamp 12V 50W
- [041] - 70176 - Socket 8-pole Halogen Lamp
- [050] - 400263 - Type K thermocouple
- [051] - 105679 - Resistance thermometer PT500
- [051 Innen] - 70510 - Seal for bottom part of the lamp
- [052] - 400266 - Temperature probe
- [060] - 105686 - Sealing rope

Part: EBO Frame for lamps-lower part

Part-Number: 70508

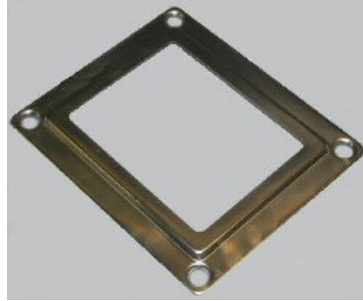

Part: EBO protective glass f. lamps-lower part

Part-Number: 70509

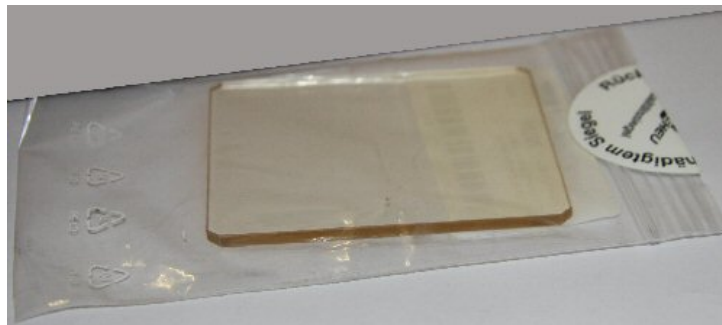

Part: Stone plates EBO 128

Part-Number: 105690



Part: Seal for tube heater

Part-Number: 105683



Part: Tube Heater 500W / 230V

Part-Number: 403112



Part: Tube Heater 700W /230V

Part-Number: 403113



Part: Halogen Lamp 12V 50W

Part-Number: 70179



Part: Socket 8-pole Halogen Lamp

Part-Number: 70176

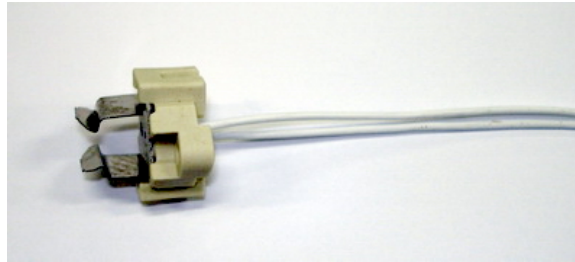

Part: Type K thermocouple

Part-Number: 400263

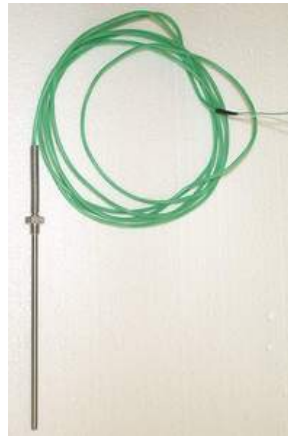

Part: Resistance thermometer PT500

Part-Number: 105679

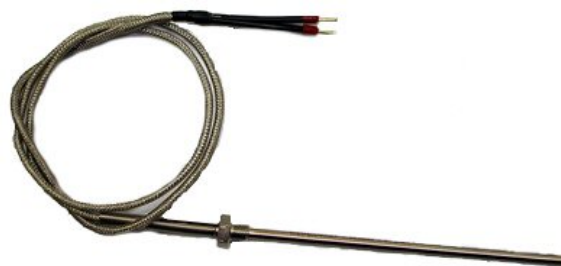

Part: Seal for bottom part of the lamp

Part-Number: 70510



Part: Temperature probe

Part-Number: 400266



Part: Sealing rope

Part-Number: 105686



Service manual Control EBO

Version: 2.00

Ident: B1-EBO 128

Series: EBO

Part-Number: 500174

This part can be ordered.



Chapter

- 500203 - Control Unit digital with Night start - V:2.00
- 500180 - Operating Unit Honeywell - V:2.00
- 500179 - Operating Unit IS 400 (Panel-Format) - V:2.00
- 400502 - Operating Unit IS 500 EBO - V:2.00
- 101347 - Operating Unit IS 600 EBO - V:2.00

Service manual

Control Unit digital with Night start

Version: 2.00

Ident: B1-EBO 128

Series: EBO

Part-Number: 500203

This part can be ordered.



Chapter

38099 - Control digital with Night start, complete

Part: Control digital with Night start, complete

Part-Number: 38099



Vor Arbeitsbeginn bitte Netztrennung vornehmen.

Service manual Operating Unit Honeywell

Version: 2.00

Ident: B1-EBO 128

Series: EBO

Part-Number: 500180

This part can be ordered.

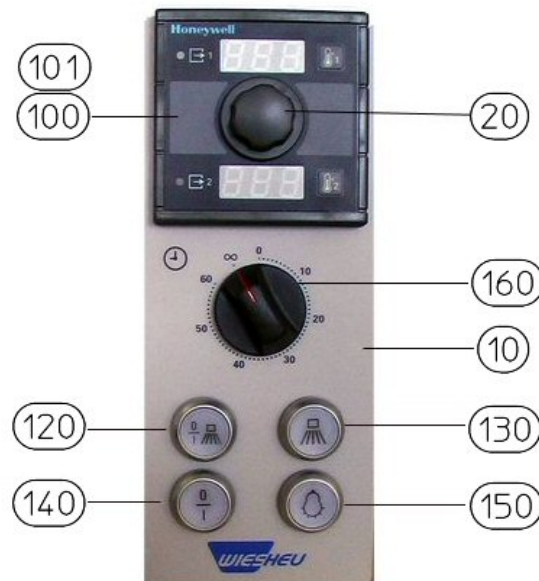

Chapter

- [010] - 400232 - Operating Foil honeywell
- [020] - 9040-155-001 - Dial knob Honeywell -Regulator
- [100] - 70046 - Honeywell control (max. 300°C)
- [101] - 70048 - Honeywell control (max. 400°C)
- [120] - 400777 - Push button "baking chamber illuminating"
- [130] - 400778 - Illuminated push button "steam"
- [140] - 400774 - Illuminated push button "On-/Off"
- [150] - 400776 - Push button "baking chamber illuminating"
- [160] - 36691 - Knob timer
- [xxx] - 36058 - Buzzer
- [xxx] - 400266 - Temperature probe
- [xxx] - 400769 - Illuminated notch
- [xxx] - 400770 - Illuminated notch
- [xxx] - 400771 - Illuminated key attachment adapter
- [xxx] - 400772 - Illuminated key LED 230 V
- [xxx] - 400773 - Illuminated key closing contact
- [xxx] - 78012 - Timer

Part: Operating Foil honeywell

Part-Number: 400232

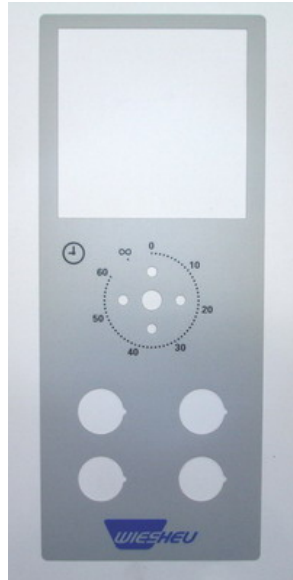

Part: Dial knob Honeywell -Regulator

Part-Number: 9040-155-001



Part: Honeywell control (max. 300°C)

Part-Number: 70046

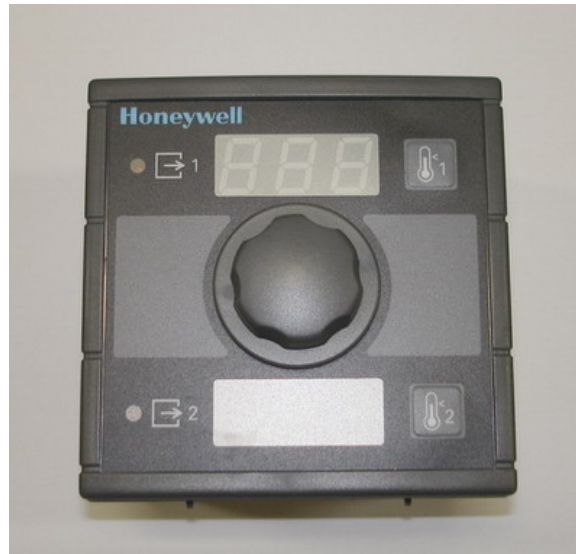

Part: Honeywell control (max. 400°C)

Part-Number: 70048

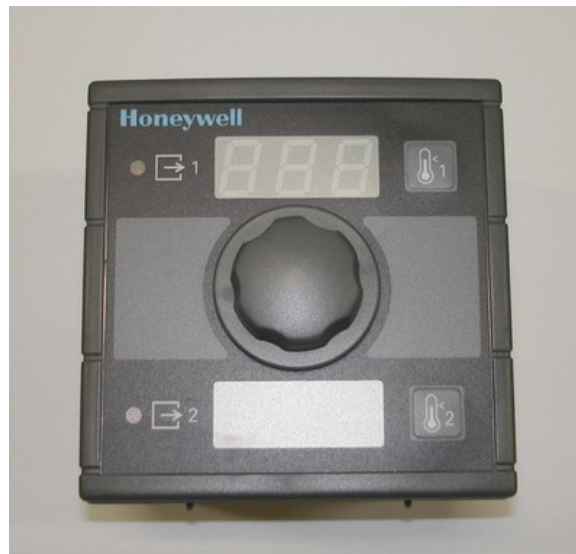

Part: Push button "baking chamber illuminating"

Part-Number: 400777

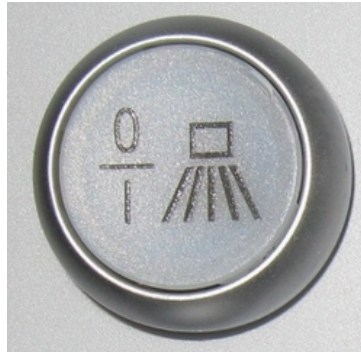

Part: Illuminated push button "steam"

Part-Number: 400778



Part: Illuminated push button "On-/Off"

Part-Number: 400774



Part: Push button "baking chamber illuminating"

Part-Number: 400776



Part: Knob timer

Part-Number: 36691

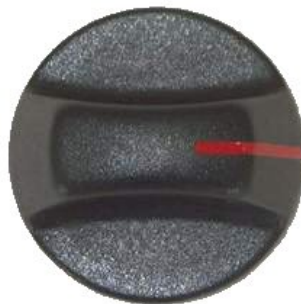

Part: Buzzer

Part-Number: 36058



Part: Temperature probe

Part-Number: 400266



Part: Illuminated notch

Part-Number: 400769



Part: Illuminated notch

Part-Number: 400770



Part: Illuminated key attachment adapter

Part-Number: 400771



Part: Illuminated key LED 230 V

Part-Number: 400772



Part: Illuminated key closing contact

Part-Number: 400773



Part: Timer

Part-Number: 78012



Service manual Operating Unit IS 400 (Panel-Format)

Version: 2.00

Ident: B1-EBO 128

Series: EBO

Part-Number: 500179

This part can be ordered.



Chapter

105440 - Operating Foil IS400

105725 - Circuit Board IS 400

Part: Operating Foil IS400

Part-Number: 105440

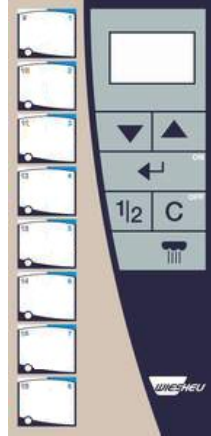

Part: Circuit Board IS 400

Part-Number: 105725



Vor Arbeitsbeginn bitte Netztrennung vornehmen.



Service manual

Operating Unit IS 500 EBO

Version: 2.00

Ident: B1-EBO 128

Series: EBO

Part-Number: 400502

This part can be ordered.

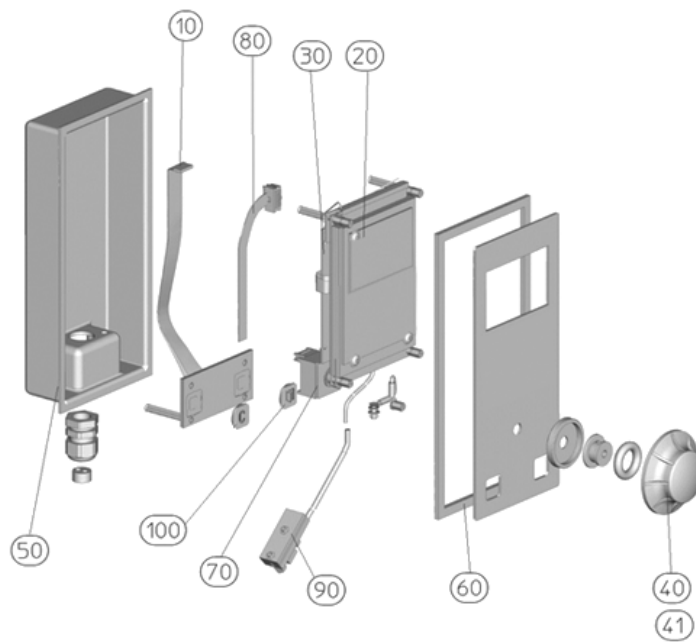

Chapter

- [010] - 101563 - Key block
- [020] - 100804 - Display IS500 with circuit board
- [030] - 105564 - Electronic Circuit Board IS500
- [040] - 102685 - Knob grey
- [050] - 102450 - Frame IS
- [060] - 102449 - Seal for frame IS
- [070] - 100591 - Incremental encoder
- [080] - 104353 - Ribbon cable for IS500
- [090] - 102806 - USB port with data wire

Part: Key block

Part-Number: 101563



Part: Display IS500 with circuit board

Part-Number: 100804



Part: Electronic Circuit Board IS500

Part-Number: 105564

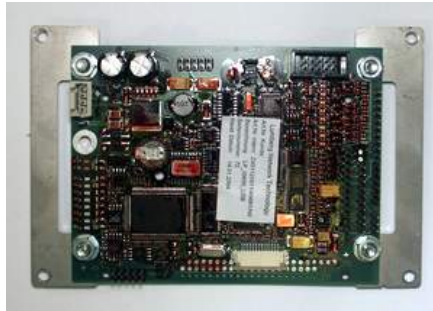

Part: Knob grey

Part-Number: 102685



Part: Frame IS

Part-Number: 102450



Part: Seal for frame IS

Part-Number: 102449

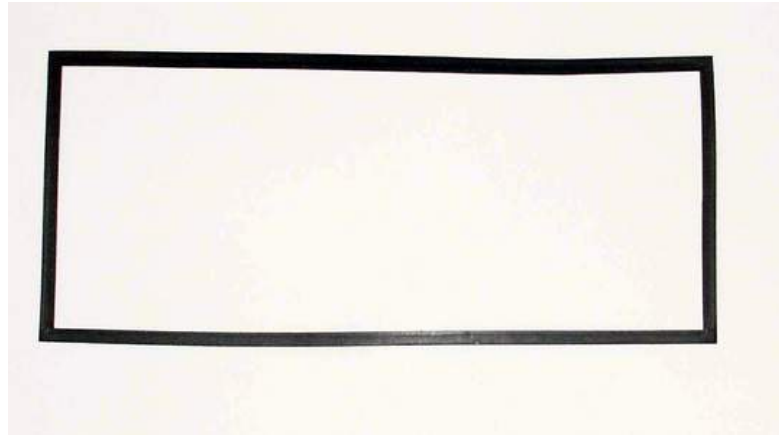

Part: Incremental encoder

Part-Number: 100591



Part: Ribbon cable for IS500

Part-Number: 104353



Part: USB port with data wire

Part-Number: 102806

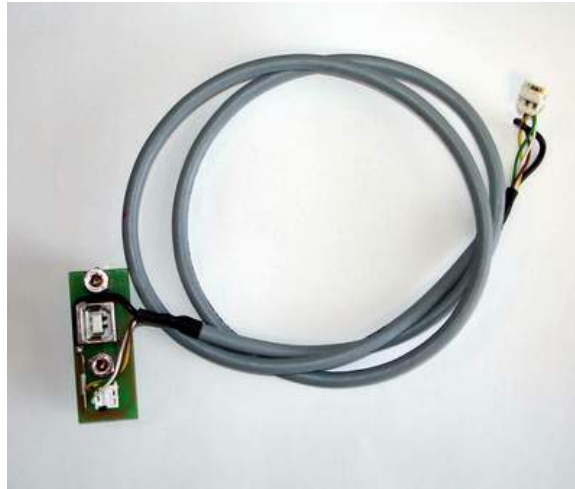

Service manual

Operating Unit IS 600 EBO

Version: 2.00

Ident: B1-EBO 128

Series: EBO

Part-Number: 101347

This part can be ordered.

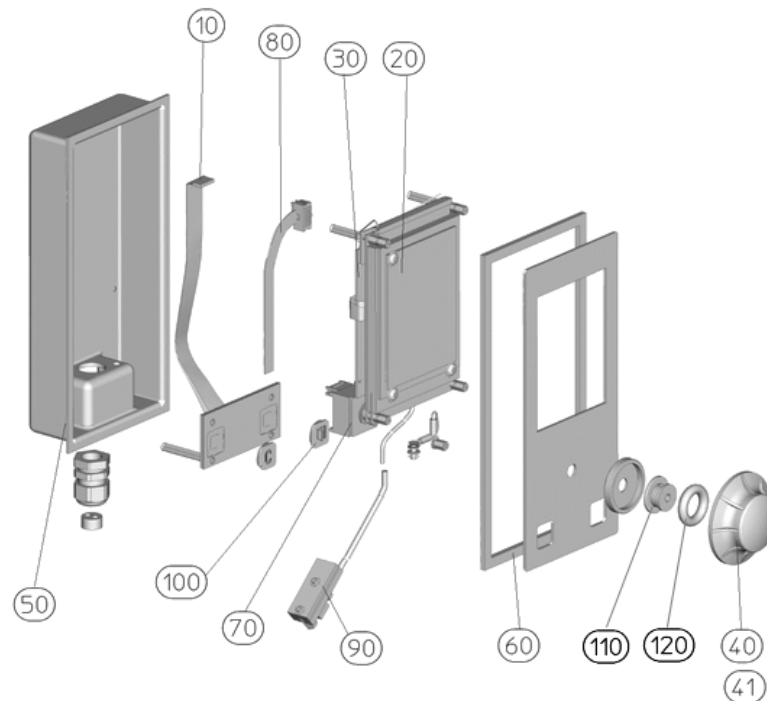

Chapter

- [010] - 101563 - Key block
- [020] - 100617 - Display IS600 with circuit board
- [030] - 101107 - Electronic Circuit Board IS600
- [040] - 102685 - Knob grey
- [041] - 101350 - Knob silver
- [050] - 102450 - Frame IS
- [060] - 102449 - Seal for frame IS
- [070] - 100591 - Incremental encoder
- [080] - 104354 - Ribbon cable for IS600
- [090] - 102806 - USB port with data wire
- [100] - 105849 - Key "C / door"
- [110] - 101434 - Adapter_D54x22
- [120] - 101435 - O-Ring_D16x7_NBR60

Part: Key block

Part-Number: 101563



Part: Display IS600 with circuit board

Part-Number: 100617



Part: Electronic Circuit Board IS600

Part-Number: 101107



Part: Knob grey

Part-Number: 102685



Part: Knob silver

Part-Number: 101350



Part: Frame IS

Part-Number: 102450



Part: Seal for frame IS

Part-Number: 102449

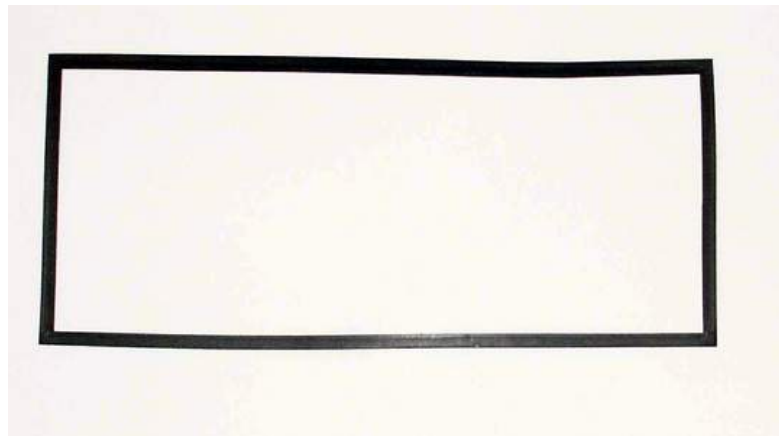

Part: Incremental encoder

Part-Number: 100591



Part: Ribbon cable for IS600

Part-Number: 104354



Part: USB port with data wire

Part-Number: 102806



Part: Key "C / door"

Part-Number: 105849

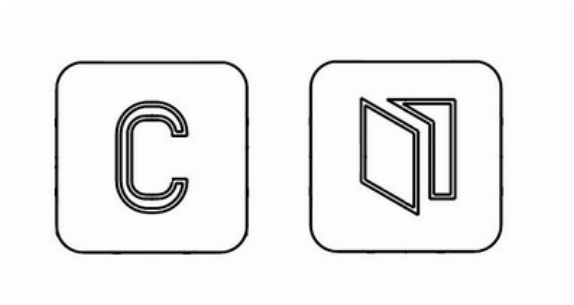

Part: Adapter_D54x22

Part-Number: 101434



Part: O-Ring_D16x7_NBR60

Part-Number: 101435

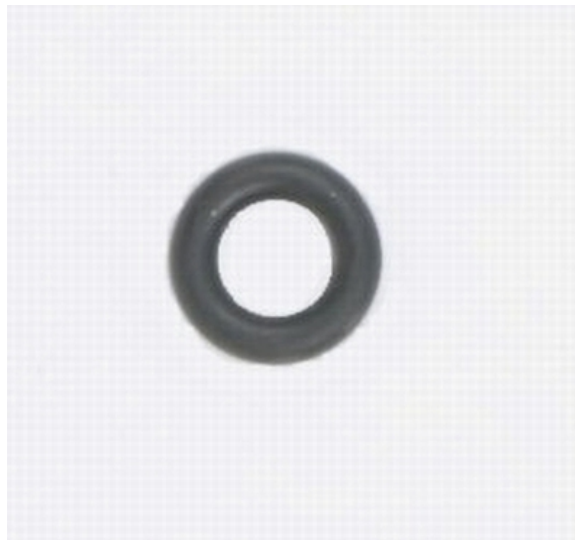

Service manual

Door EBO 124/128

Version: 2.00

Ident: B1-EBO 128

Series: EBO

Part-Number: 500172

This part can be ordered.

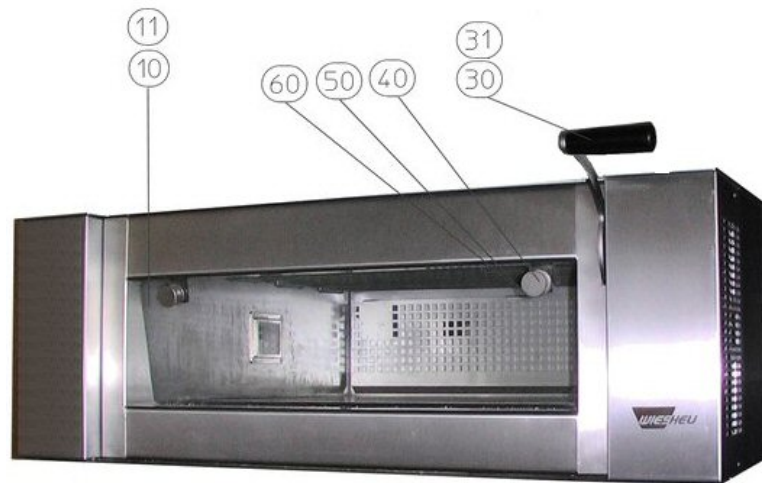

Chapter

- [010] - 105677 - Glass pane EBO124/128 high chamber
- [011] - 105678 - Glass pane EBO124/128 low chamber
- [020] - 400765 - Tension spring
- [030] - 70148 - Door handle black
- [031] - 70025 - Screw
- [032] - 403240 - Door lever
- [033] - 400817 - Spring holder
- [034] - 36068 - Spring ring
- [035] - 403232 - Bush
- [036] - 435015 - Screw nut
- [037] - 431126 - Hexagon screw
- [040] - 70210 - Knurled screw DIN 635
- [050] - 33878 - Glass plate holder silicone
- [060] - 403222 - Silicone pad

Part: Glass pane EBO124/128 high chamber

Part-Number: 105677



Part: Glass pane EBO124/128 low chamber

Part-Number: 105678



Part: Tension spring

Part-Number: 400765



Part: Door handle black

Part-Number: 70148



Part: Screw

Part-Number: 70025



Part: Door lever

Part-Number: 403240

Part: Spring holder

Part-Number: 400817

Part: Spring ring

Part-Number: 36068

Part: Bush

Part-Number: 403232

Part: Screw nut

Part-Number: 435015

Part: Hexagon screw

Part-Number: 431126

Part: Knurled screw DIN 635

Part-Number: 70210



Part: Glass plate holder silicone

Part-Number: 33878



Part: Silicone pad

Part-Number: 403222



Service manual

Electric-Installation digital/MAN

Version: 2.00

Ident: B1-EBO 128

Series: EBO

Part-Number: 500183

This part can be ordered.

Chapter

- [010] - 36058 - Buzzer
- [011] - 401523 - Loudspeaker
- [020] - 38086 - Knop thermostat
- [021] - 70355 - Safety limit switch
- [030] - 70511 - Transformer
- [040] - 33884 - Relay main switch
- [050] - 80131 - Time Relay EZ12AW-230V
- [060] - 70508 - EBO Frame for lamps-lower part
- [070] - 70509 - EBO protective glass f. lamps-lower part

Part: Buzzer

Part-Number: 36058



Part: Loudspeaker

Part-Number: 401523



Part: Knop thermostat

Part-Number: 38086



Part: Safety limit switch

Part-Number: 70355

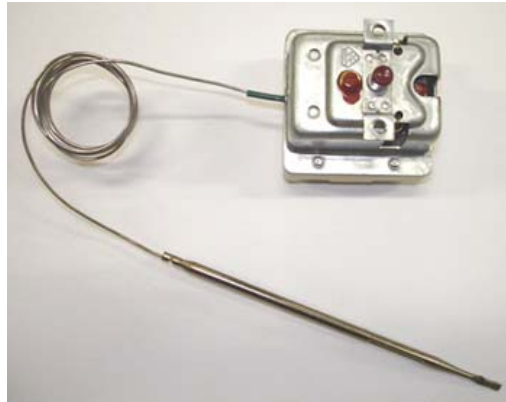

Part: Transformer

Part-Number: 70511



Part: Relay main switch

Part-Number: 33884



Part: Time Relay EZ12AW-230V

Part-Number: 80131

Part: EBO Frame for lamps-lower part

Part-Number: 70508



Part: EBO protective glass f. lamps-lower part

Part-Number: 70509

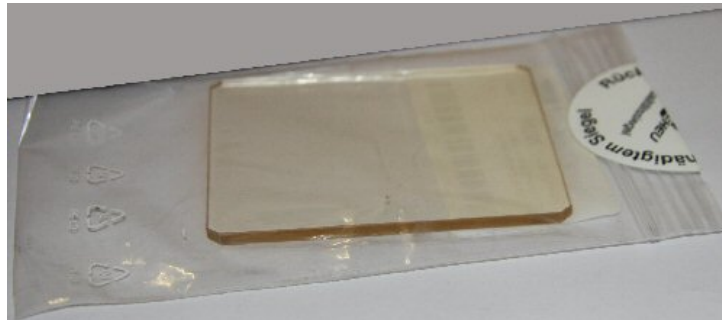

Service manual Electric-Installation IS 500/600

Version: 2.00

Ident: B1-EBO 128

Series: EBO

Part-Number: 500184

This part can be ordered.

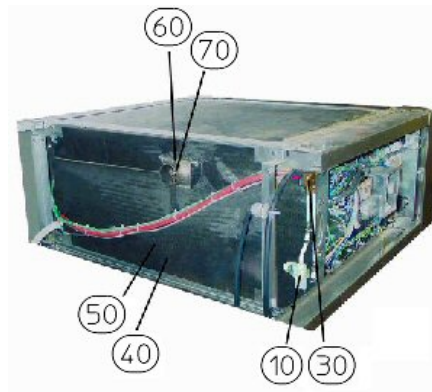

Chapter

- [010] - 101106 - Power board
- [020] - 401523 - Loudspeaker
- [070] - 33884 - Relay main switch
- [080] - 70511 - Transformer
- [090] - 70355 - Safety limit switch
- [100] - 70508 - EBO Frame for lamps-lower part
- [110] - 70509 - EBO protective glass f. lamps-lower part

Part: Power board

Part-Number: 101106



Part: Loudspeaker

Part-Number: 401523



Part: Relay main switch

Part-Number: 33884



Part: Transformer

Part-Number: 70511



Part: Safety limit switch

Part-Number: 70355

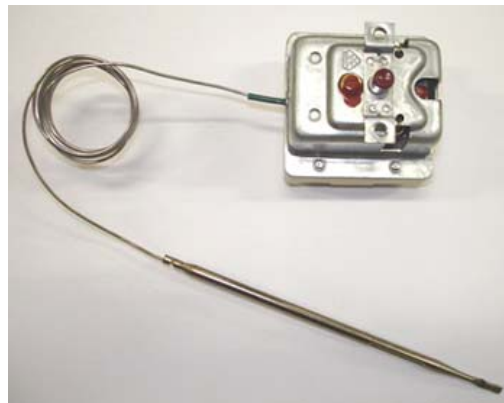

Part: EBO Frame for lamps-lower part

Part-Number: 70508

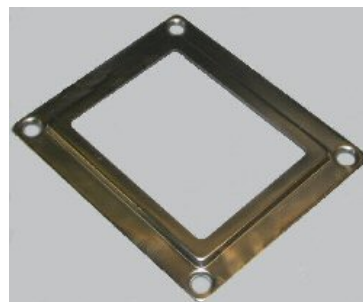

Part: EBO protective glass f. lamps-lower part

Part-Number: 70509



Service manual Frame EBO

Version: 2.00

Ident: B1-EBO 128

Series: EBO

Part-Number: 500176

This part can be ordered.

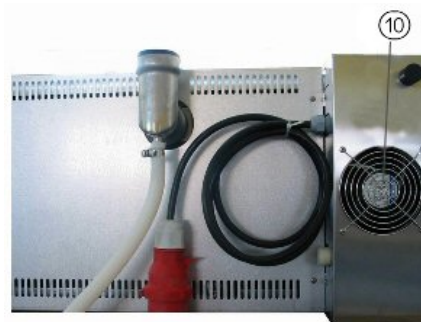

Chapter

[010] - 402662 - Axial Blower 19W heat resistance until 75°C

Part: Axial Blower 19W heat resistance until 75°C

Part-Number: 402662



Service manual Installation room EBO128 400V 50Hz

Version: 2.00

Ident: B1-EBO 128

Series: EBO

Part-Number: 500175

This part can be ordered.

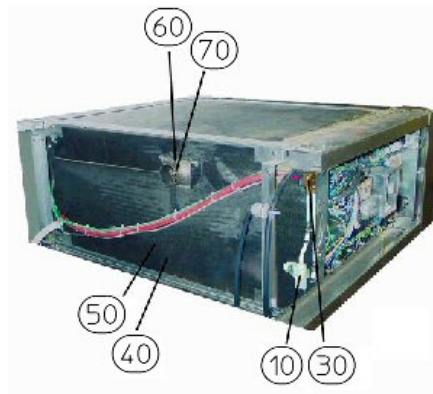

Chapter

403109 - Steam Generator EBO128 400V 50Hz - V:2.00

- [010] - 403754 - Solenoid valve (flow restrictor)
- [030] - 36126 - Water flow detector flow meter FH20
- [050] - 03617 - Seal for steam generator
- [060] - 78063 - Seal for air case
- [070] - 105685 - Seal for air flap

Part: Solenoid valve (flow restrictor)

Part-Number: 403754



Part: Water flow detector flow meter FH20

Part-Number: 36126



Part: Seal for steam generator

Part-Number: 03617

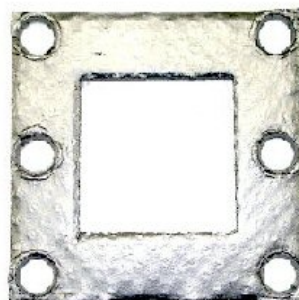

Part: Seal for air case

Part-Number: 78063

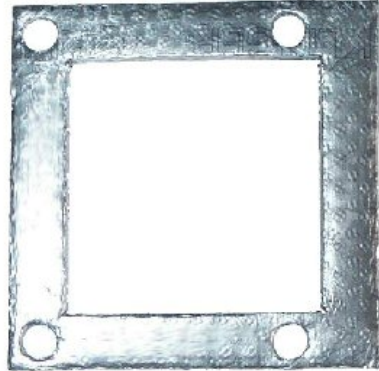

Part: Seal for air flap

Part-Number: 105685



Service manual

Steam Generator EBO128 400V 50Hz

Version: 2.00

Ident: B1-EBO 128

Series: EBO

Part-Number: 403109

This part can be ordered.

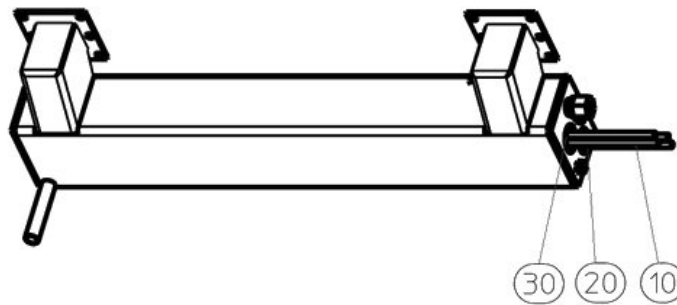

Chapter

[010] - 403107 - Tube Heater 1600W / 230V

[020] - 400263 - Type K thermocouple

[030] - 34352 - Thermostat

[040] - 403133 - Steaming Pipe

[041] - 402933 - Screwing

Part: Tube Heater 1600W / 230V

Part-Number: 403107



Part: Type K thermocouple

Part-Number: 400263

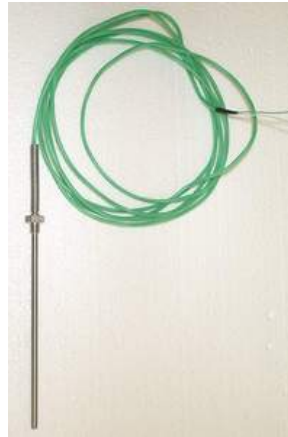

Part: Thermostat

Part-Number: 34352



Part: Steaming Pipe

Part-Number: 403133



Part: Screwing

Part-Number: 402933

Urheberrecht:

Das Urheberrecht an diesem Servicehandbuch verbleibt bei der WIESHEU GmbH. Dieses Servicehandbuch ist nur für autorisierte Servicepartner und dessen Personal bestimmt. Sie enthält Vorschriften und Hinweise, die weder vollständig noch teilweise vervielfältigt, verbreitet oder anderweitig mitgeteilt werden dürfen.

Alle Darstellungen, Zeichnungen, Bilder Texte und Angaben sind urheberrechtlich geschützt. Sie unterliegen den gewerblichen Schutzrechten.

Zu diesem Servicehandbuch:

Alle Abbildungen in diesem Dokument sollen die Verständlichkeit unterstützen. Die Abbildungen sind nicht maßstabsgerecht. Teilweise sind dem Originalprodukt ähnelnde Abbildungen dargestellt, die geringfügig abweichen können.

Achtung!

Vermeiden Sie Fehlfunktionen oder Beschädigungen durch falsche Ersatzteile. Wir empfehlen die ausschließliche Verwendung von WIESHEU-Original-Ersatzteilen.

Wiesheu GmbH
Daimlerstrasse 10
DE-71563 Affalterbach
Telefon: +49 (0)7144 / 3 03-0
Fax: +49 (0)7144 / 3 03-11
Service-Telefon: 0800-WIESHEU
E-Mail: info@wiesheu.de
www.wiesheu.de

Stand: 08.06.2010